

A high-contrast, close-up photograph of a polished chrome faucet and sink basin. The faucet handle is in the upper left, and the curved rim of the sink is in the lower left. The right side shows a portion of the sink's interior. The lighting creates bright highlights and deep shadows, emphasizing the metallic texture and smooth curves of the fixtures.

ALBORZ STEEL INDUSTRIES CO.

ALBORZ

ALBORZ STEEL INDUSTRIES CO (private joint stock) began the production of Stainless Steel Kitchen sinks in late 1980s with an annual capacity of 36,000 pieces of sinks to meet local market needs.

Today we are proud of producing 1,000,000 pieces of 91 different models of sinks per year.

Yet still, wait for another 12 totally new fantasy welded sinks, which are to be produced and presented to the market in near future.

As a leading manufacturer and exporter, not only Alborz dominates local markets, but also exports its wide range of products to 40 countries in middle East, Far East, Africa Oceania, and Europe.

In 1999, Alborz was recognized as “The Best Industrial Model Unit” by Iranian Ministry of industries.

Alborz fantasy welded sinks, produced under ISO 9001:2000 quality certificates from ITALY CISQ and IQNet (the international certification network) are the most looked-for luxury sinks in all Iranian and main regional markets.

ALBORZ STEEL INDUSTRIES CO.

Kitchen sinks model IN-SET welded type

800 IN-SET



ALBORZ STEEL INDUSTRIES CO.

Kitchen sinks model **IN-SET** welded type



Model:824

- Outer dimens(mm):980x500
- Bowl dimens(mm):383x383x170
- Small bowl dimens(mm):228x228x120
- Made of 18.8 stainless steel
- For installation in base unit of 600mm min
- Packing size(mm):1010x530x190
- Left & Right

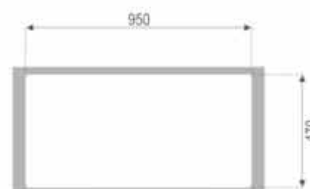
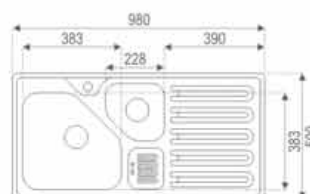

Model:810

- Outer dimens(mm):600x500
- Bowl dimens(mm):383x383x170
- Made of 18.8 stainless steel
- For installation in base unit of 600mm min
- Packing size(mm):630x530x190
- Left & Right

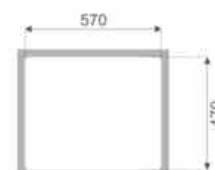
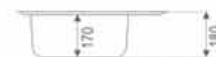
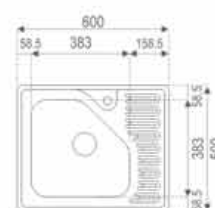

ALBORZ STEEL INDUSTRIES CO.

Kitchen sinks model IN-SET welded type

700 IN-SET



ALBORZ STEEL INDUSTRIES CO.

Kitchen sinks model **IN-SET** welded type



Model:754

- Outer dimens(mm):956x510
- Bowl dimens(mm):410x410x170
- Small bowl dimens(mm):300x200x140
- Made of 18.8 stainless steel
- For installation in base unit of 600mm min
- Packing size(mm):980x540x190
- Left & Right

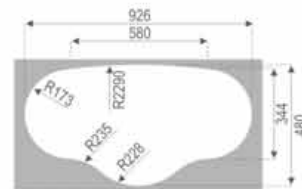
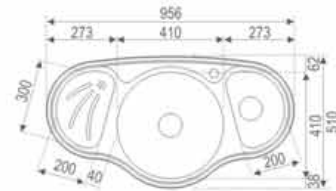

Model:750

- Outer dimens(mm):960x520
- Bowl dimens(mm):410x410x170
- Made of 18.8 stainless steel
- For installation in base unit of 600mm min
- Packing size(mm):990x550x190

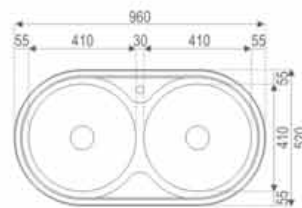

ALBORZ STEEL INDUSTRIES CO.

Kitchen sinks model **IN-SET** welded type



Model:744

- Outer dimens(mm):956x510
- Bowl dimens(mm):410x410x170
- Made of 18.8 stainless steel
- For installation in base unit of 600mm min
- Packing size(mm):980x540x190

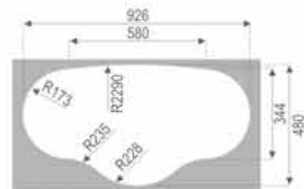
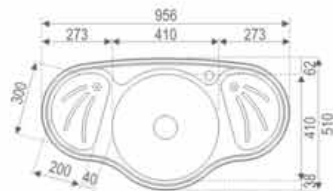

Model:740

- Outer dimens(mm):960x520
- Bowl dimens(mm):410x410x170
- Made of 18.8 stainless steel
- For installation in base unit of 600mm min
- Packing size(mm):990x550x190
- Left & Right

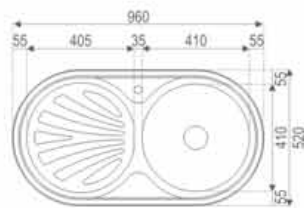

ALBORZ STEEL INDUSTRIES CO.

Kitchen sinks model **IN-SET** welded type



Model: 170

- Outer dimens(mm):458x458
- Bowl dimens(mm):410x410x170
- Made of 18.8 stainless steel
- For installation in base unit of 600mm min
- Packing size(mm):490x490x190

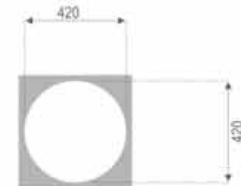
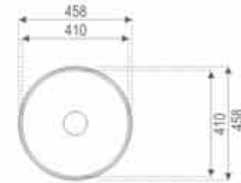

Model: 725

- Outer dimens(mm):1200x500
- Bowl dimens(mm):330x350x150
- Made of 18.8 stainless steel
- For installation in base unit of 600mm min
- Packing size(mm):1230x530x190
- Left & Right

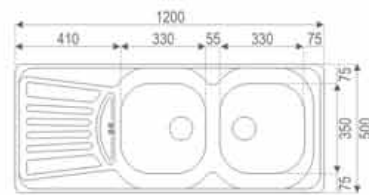

ALBORZ STEEL INDUSTRIES CO.

Kitchen sinks model **IN-SET** welded type



Model:720

- Outer dimens(mm):1000x520
- Bowl dimens(mm):440x345x170
- Small bowl dimens(mm):300x165x130
- Made of 18.8 stainless steel
- For installation in base unit of 600mm min
- Packing size(mm):1030x550x190

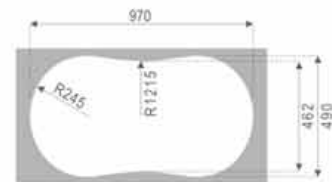
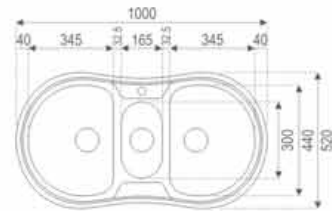

Model:710

- Outer dimens(mm):1000x520
- Bowl dimens(mm):440x345x170
- Small bowl dimens(mm):300x165x130
- Made of 18.8 stainless steel
- For installation in base unit of 600mm min
- Packing size(mm):1030x550x190
- Left & Right

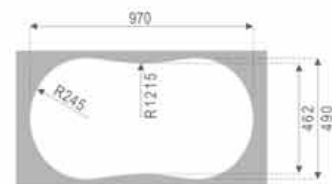
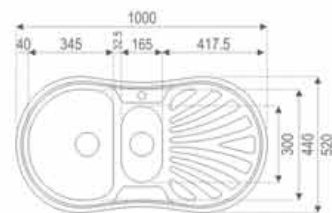
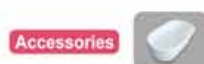

ALBORZ STEEL INDUSTRIES CO.

Kitchen sinks model IN-SET welded type

700 IN-SET



ALBORZ STEEL INDUSTRIES CO.

Kitchen sinks model IN-SET welded type



600 IN-SET

ALBORZ STEEL INDUSTRIES CO.

Kitchen sinks model **IN-SET** welded type



Model:624

- Outer dimens(mm):1160x510
- Bowl dimens(mm):410x350x170
- Small bowl dimens(mm):350x330x150
- Made of 18.8 stainless steel
- For installation in base unit of 600mm min
- Packing size(mm):1190x540x190

Accessories

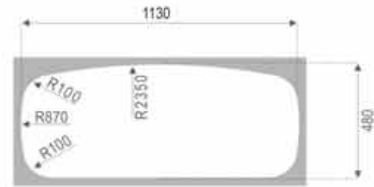
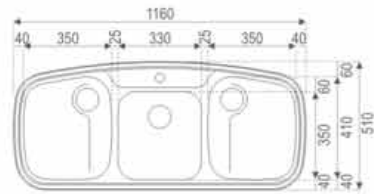

Model:620

- Outer dimens(mm):1000x510
- Bowl dimens(mm):410x350x170
- Small bowl dimens(mm):300x165x130
- Made of 18.8 stainless steel
- For installation in base unit of 600mm min
- Packing size(mm):1030x540x190

Accessories

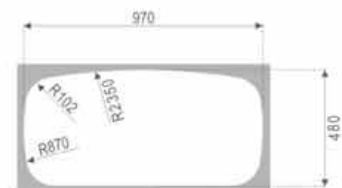
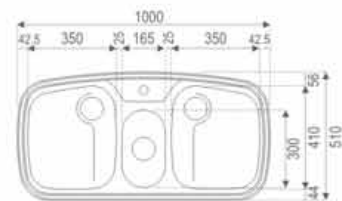

ALBORZ STEEL INDUSTRIES CO.

Kitchen sinks model **IN-SET** welded type



Model:614

- Outer dimens(mm):1160x510
- Bowl dimens(mm):410x350x170
- Small bowl dimens(mm):350x330x150
- Made of 18.8 stainless steel
- For installation in base unit of 600mm min
- Packing size(mm):1190x540x190
- Left&Right

Accessories

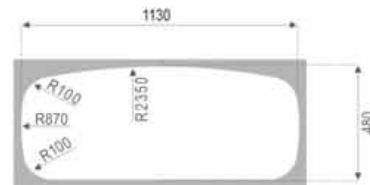
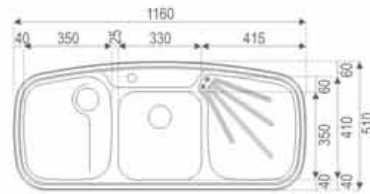

Model:610

- Outer dimens(mm):1000x510
- Bowl dimens(mm):410x350x170
- Small bowl dimens(mm):300x165x130
- Made of 18.8 stainless steel
- For installation in base unit of 600mm min
- Packing size(mm):1030x540x190
- Left&Right

Accessories

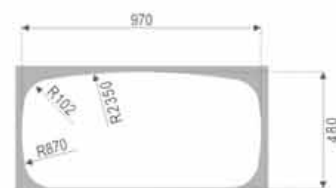
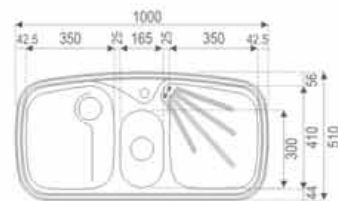

ALBORZ STEEL INDUSTRIES CO.

Kitchen sinks model **IN-SET** welded type



Model:604

- Outer dimens(mm):1160x510
- Bowl dimens(mm):350x330x150
- Made of 18.8 stainless steel
- For installation in base unit of 600mm min
- Packing size(mm):1190x540x190

Accessories

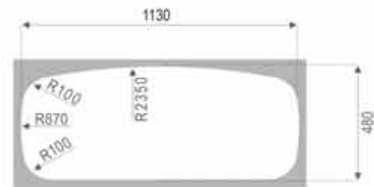
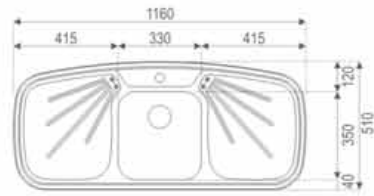

ALBORZ STEEL INDUSTRIES CO.

Kitchen sinks model IN-SET welded type

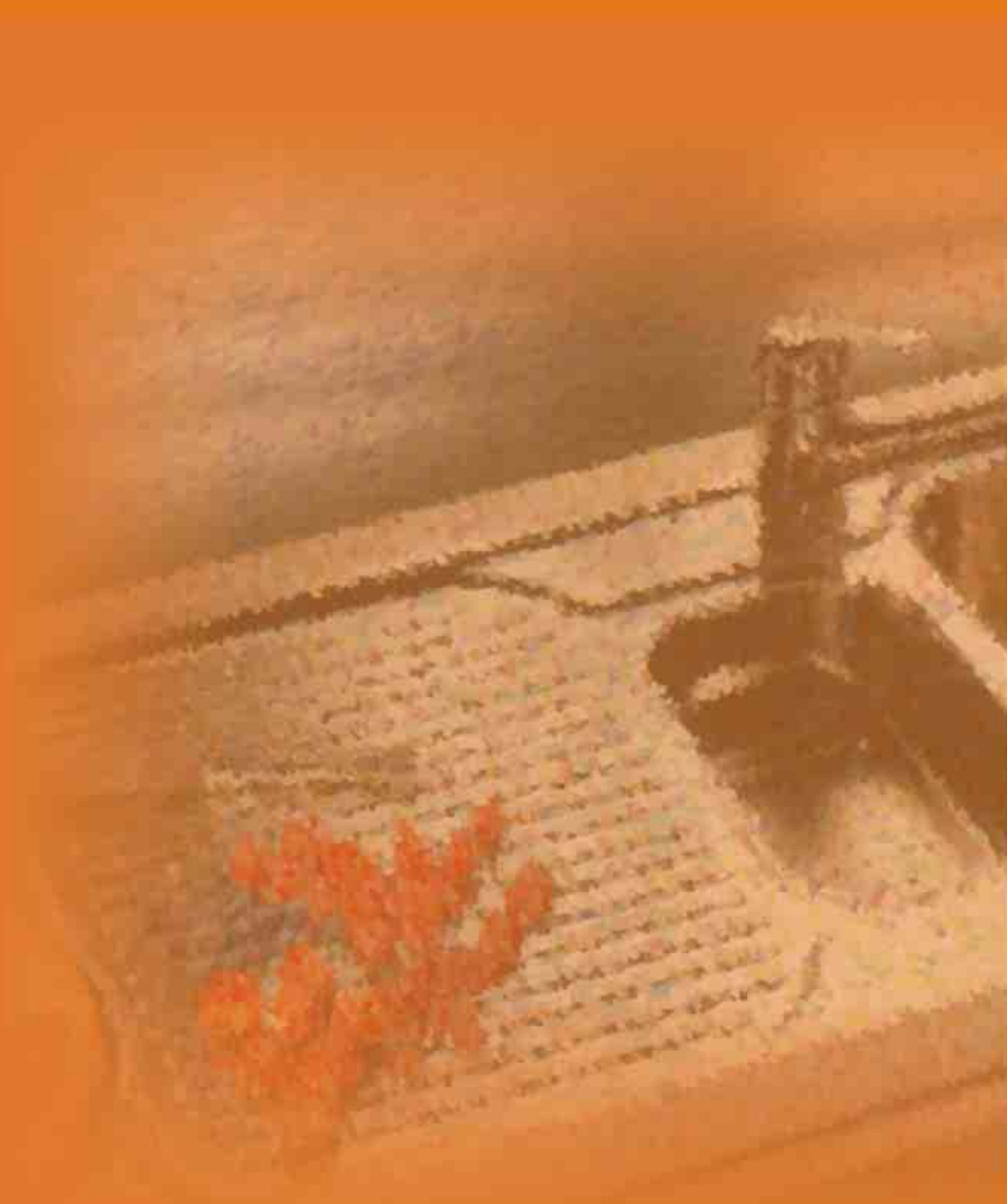

500 IN-SET

ALBORZ STEEL INDUSTRIES CO.

Kitchen sinks model **IN-SET** welded type



Model:595

- Outer dimens(mm):1325x500
- Bowl dimens(mm):420x340x170
- Small bowl dimens(mm):300x165x130
- Made of 18.8 stainless steel
- For installation in base unit of 600mm min
- Packing size(mm):1350x530x190
- Left & right

Accessories

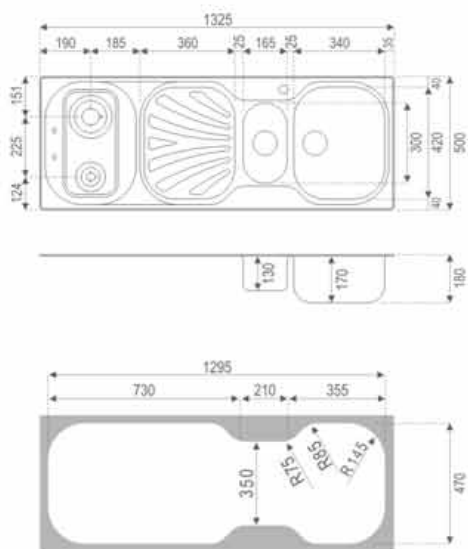

Model:590

- Outer dimens(mm):1325x510
- Bowl dimens(mm):420x340x170
- Small bowl dimens(mm):300x165x130
- Made of 18.8 stainless steel
- For installation in base unit of 600mm min
- Packing size(mm):1350x530x190
- Left & right

Accessories

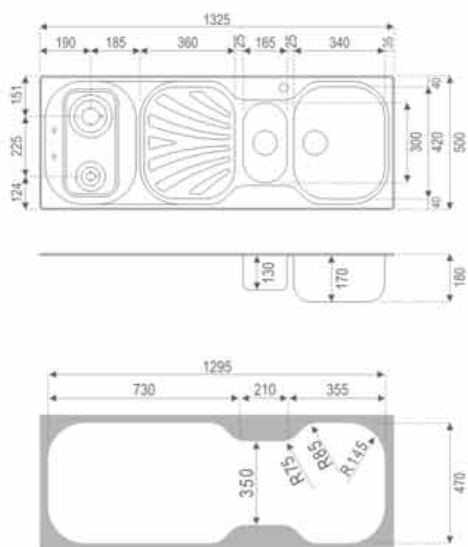

ALBORZ STEEL INDUSTRIES CO.

Kitchen sinks model **IN-SET** welded type



Model:542

- Outer dimens(mm):830x830
- Bowl dimens(mm):420x340x170
- Small bowl dimens(mm):300x165x130
- Made of 18.8 stainless steel
- For installation in base unit of 600mm min
- Packing size(mm):860x860x190

Accessories

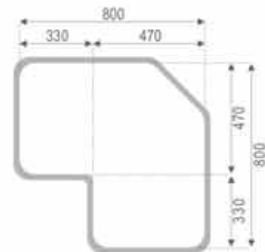
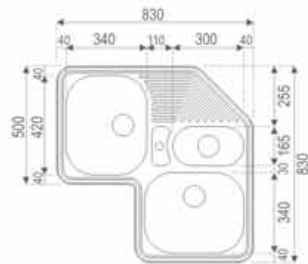

Model:540

- Outer dimens(mm):830x830
- Bowl dimens(mm):420x340x170
- Made of 18.8 stainless steel
- For installation in base unit of 600mm min
- Packing size(mm):860x860x190

Accessories

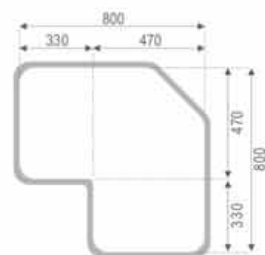
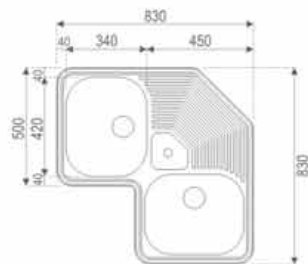

ALBORZ STEEL INDUSTRIES CO.

Kitchen sinks model **IN-SET** welded type



Model:530

- Outer dimens(mm):1325x500
- Bowl dimens(mm):420x340x170
- Small bowl dimens(mm):300x165x130
- Made of 18.8 stainless steel
- For installation in base unit of 600mm min
- Packing size(mm):1350x530x190
- Left & Right

Accessories

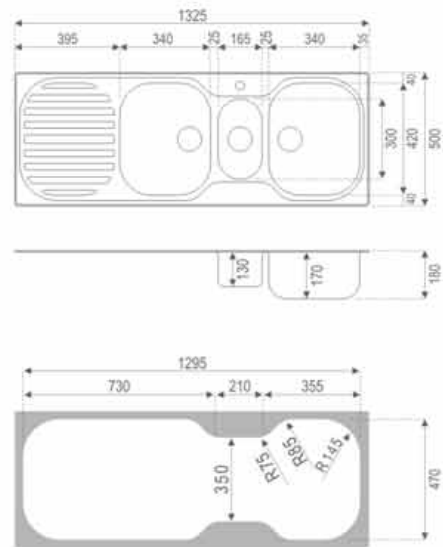

Model:520

- Outer dimens(mm):965x500
- Bowl dimens(mm):420x340x170
- Small bowl dimens(mm):300x165x130
- Made of 18.8 stainless steel
- For installation in base unit of 600mm min
- Packing size(mm):1000x530x190

Accessories

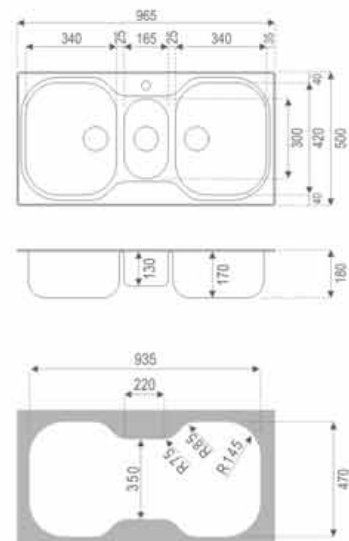

ALBORZ STEEL INDUSTRIES CO.

Kitchen sinks model **IN-SET** welded type



Model:510

- Outer dimens(mm):965x500
- Bowl dimens(mm):420x340x170
- Small bowl dimens(mm):300x165x130
- Made of 18.8 stainless steel
- For installation in base unit of 600mm min
- Packing size(mm):1000x530x190
- Left & Right

Accessories

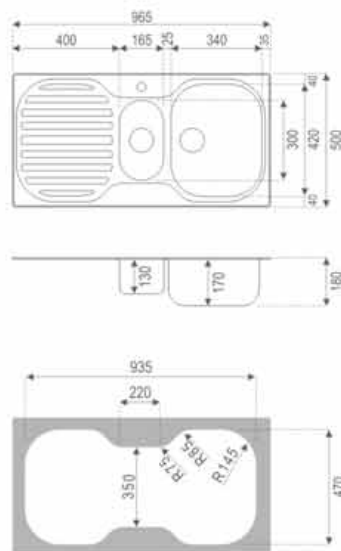

ALBORZ STEEL INDUSTRIES CO (private joint stock) began the production of Stainless Steel Kitchen sinks in late 1980s with an annual capacity of 36,000 pieces of sinks to meet local market needs.

Today we are proud of producing 1,000,000 pieces of 91 different models of sinks per year.

Yet still, wait for another 12 totally new fantasy welded sinks, which are to be produced and presented to the market in near future.

As a leading manufacturer and exporter, not only Alborz dominates local markets, but also exports its wide range of products to 40 countries in middle East, Far East, Africa Oceania, and Europe.

In 1999, Alborz was recognized as "The Best Industrial Model Unit" by Iranian Ministry of industries.

Alborz fantasy welded sinks, produced under ISO 9001:2000 quality certificates from ITALY CISQ and IQNet (the international certification network) are the most looked-for luxury sinks in all Iranian and main regional markets.

ALBORZ STEEL INDUSTRIES CO.

Kitchen sinks model SIT-ON welded type



700 SIT-ON

ALBORZ STEEL INDUSTRIES CO.

Kitchen sinks model **SIT-ON** welded type

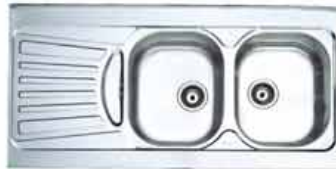

Model:725/60

- Outer dimens(mm):1200x600
- Bowl dimens(mm):420x340x170
- Made of 18.8 stainless steel
- For installation in base unit of 600mm min
- Packing size(mm):1230x630x210
- Left & right

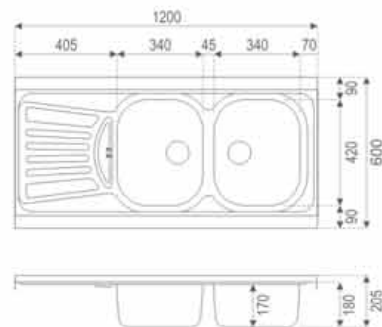

Accessories



Model:725/50

- Outer dimens(mm):1200x500
- Bowl dimens(mm):330x350x150
- Made of 18.8 stainless steel
- For installation in base unit of 600mm min
- Packing size(mm):1230x530x190
- Left & right

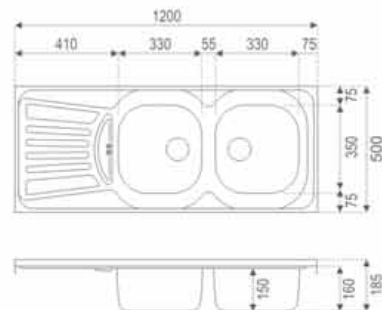

ALBORZ STEEL INDUSTRIES CO.

Kitchen sinks model **SIT-ON** welded type



Model:720/60

- Outer dimens(mm):1000x600
- Bowl dimens(mm):440x345x170
- Small bowl dimens(mm):300x165x130
- Made of 18.8 stainless steel
- For installation in base unit of 600mm min
- Packing size(mm):1030x630x210

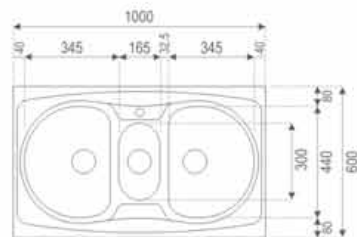

Model:710/60

- Outer dimens(mm):1000x500
- Bowl dimens(mm):440x345x170
- Small bowl dimens(mm):300x165x130
- Made of 18.8 stainless steel
- For installation in base unit of 600mm min
- Packing size(mm):1030x630x210
- Left & right

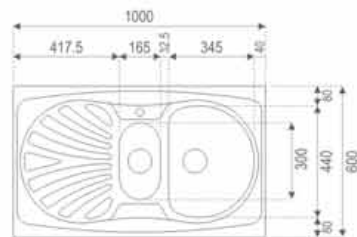

ALBORZ STEEL INDUSTRIES CO.

Kitchen sinks model SIT-ON welded type

700 SIT-ON



ALBORZ STEEL INDUSTRIES CO.

Kitchen sinks model SIT-ON welded type



600 SIT-ON

ALBORZ STEEL INDUSTRIES CO.

Kitchen sinks model **SIT-ON** welded type



Model:624/60

- Outer dimens(mm):1200x600
- Bowl dimens(mm):410x350x170
- Small bowl dimens(mm):350x330x150
- Made of 18.8 stainless steel
- For installation in base unit of 600mm min
- Packing size(mm):1230x630x210

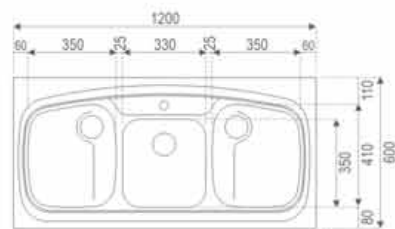

Accessories



Model:620/60

- Outer dimens(mm):1000x600
- Bowl dimens(mm):410x350x170
- Small bowl dimens(mm):300x165x130
- Made of 18.8 stainless steel
- For installation in base unit of 600mm min
- Packing size(mm):1030x630x210

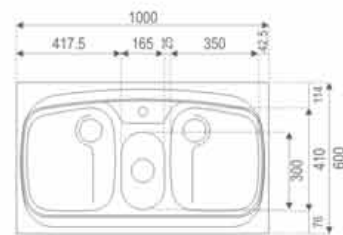

Accessories



ALBORZ STEEL INDUSTRIES CO.

Kitchen sinks model **SIT-ON** welded type



Model:620/50

- Outer dimens(mm):1000x500
- Bowl dimens(mm):355x335x150
- Small bowl dimens(mm):300x164x130
- Made of 18.8 stainless steel
- For installation in base unit of 600mm min
- Packing size(mm):1030x530x190

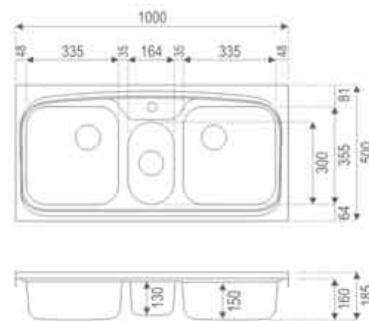

Model:614/60

- Outer dimens(mm):1200x600
- Bowl dimens(mm):410x350x170
- Small bowl dimens(mm):350x330x150
- Made of 18.8 stainless steel
- For installation in base unit of 600mm min
- Packing size(mm):1230x630x210
- Left & Right

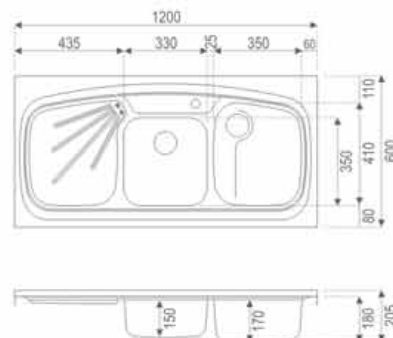

ALBORZ STEEL INDUSTRIES CO.

Kitchen sinks model **SIT-ON** welded type



Model: 610/60

- Outer dimens(mm):1000x600
- Bowl dimens(mm):410x350x170
- Small bowl dimens(mm):300x165x130
- Made of 18.8 stainless steel
- For installation in base unit of 600mm min
- Packing size(mm):1030x630x210
- Left & Right

Accessories

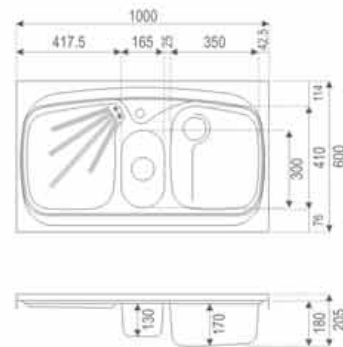

Model: 610/50

- Outer dimens(mm):1000x500
- Bowl dimens(mm):355x335x150
- Small bowl dimens(mm):300x164x130
- Made of 18.8 stainless steel
- For installation in base unit of 600mm min
- Packing size(cm):1030x530x190
- Left & Right

Accessories

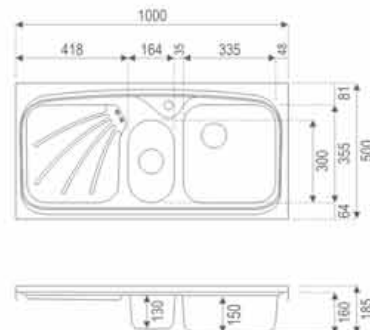

ALBORZ STEEL INDUSTRIES CO.

Kitchen sinks model **SIT-ON** welded type



Model:604/60

- Outer dimens(mm):1200x600
- Bowl dimens(mm):350x330x150
- Made of 18.8 stainless steel
- For installation in base unit of 600mm min
- Packing size(mm):1230x630x190

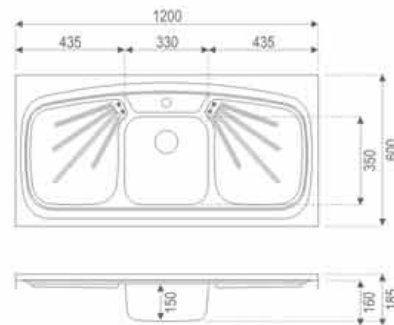

Accessories



ALBORZ STEEL INDUSTRIES CO.

Kitchen sinks model SIT-ON welded type

600 SIT-ON



ALBORZ STEEL INDUSTRIES CO.

Kitchen sinks model SIT-ON welded type



ALBORZ STEEL INDUSTRIES CO.

Kitchen sinks model **SIT-ON** welded type



Model:595/60

- Outer dimens(mm):1400x600
- Bowl dimens(mm):420x340x170
- Small bowl dimens(mm):300x165x130
- Made of 18.8 stainless steel
- For installation in base unit of 600mm min
- Packing size(mm):1430x630x210
- Left & Right

Accessories

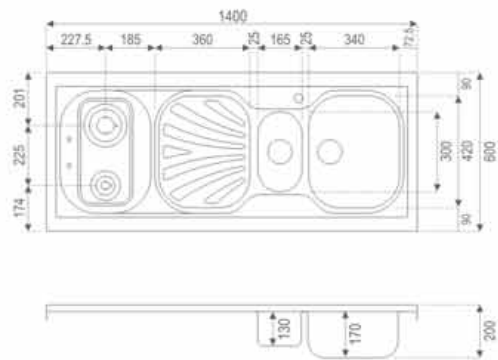

Model:590/60

- Outer dimens(mm):1400x600
- Bowl dimens(mm):420x340x170
- Small bowl dimens(mm):300x165x130
- Made of 18.8 stainless steel
- For installation in base unit of 600mm min
- Packing size(mm):1430x630x210
- Left & Right

Accessories

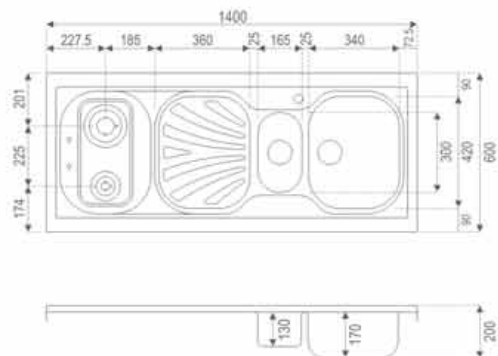

ALBORZ STEEL INDUSTRIES CO.

Kitchen sinks model **SIT-ON** welded type

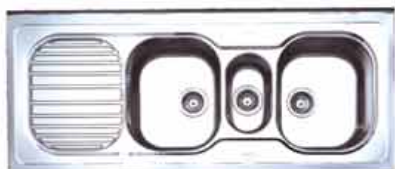

Model:530/60

- Outer dimens(mm):1400x600
- Bowl dimens(mm):420x340x170
- Small bowl dimens(mm):300x165x130
- Made of 18.8 stainless steel
- For installation in base unit of 600mm min
- Packing size(mm):1430x630x210
- Left & Right

Accessories

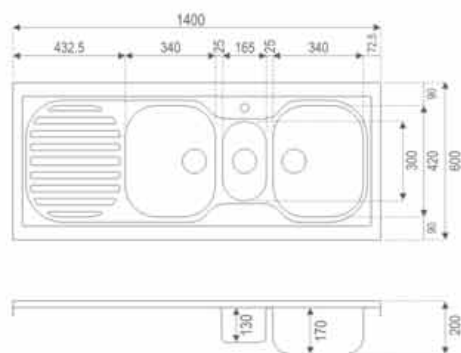

Model:520/60

- Outer dimens(mm):1000x600
- Bowl dimens(mm):420x340x170
- Small bowl dimens(mm):300x165x130
- Made of 18.8 stainless steel
- For installation in base unit of 600mm min
- Packing size(mm):1030x630x210

Accessories

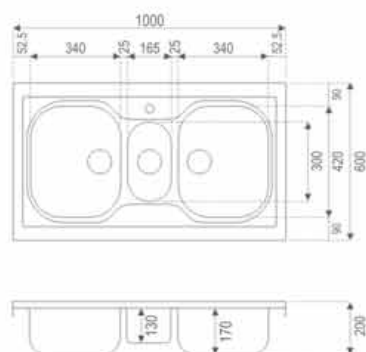

ALBORZ STEEL INDUSTRIES CO.

Kitchen sinks model SIT-ON welded type



Model:510/60

- Outer dimens(mm):1000x600
- Bowl dimens(mm):420x340x170
- Small bowl dimens(mm):300x165x130
- Made of 18.8 stainless steel
- For installation in base unit of 600mm min
- Packing size(mm):1030x630x210
- Left & Right

Accessories

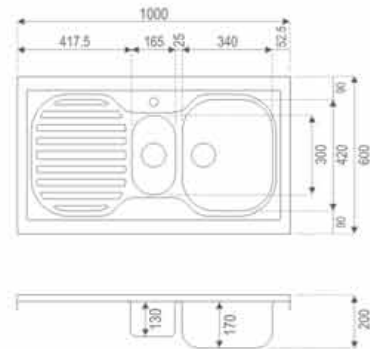





ALBORZ

No.25, Naseri St, Africa Blvd, Tehran-Iran
P.O.BOX: 19395-4516

Tel: +98 (0)21 8789494-6 Fax: +98 (0)21 8789497

URL: <http://www.steelalborz.com> E-mail: infosteel@steelalborz.com